

Xenon Light Source 300W Monochromatic Light with Filters

MAX-303

Desired wavelength irradiation for photochemical research without IR heat.



Features

- Xenon 300W lamp
- Selectable wavelength
- IR heat blocking
- Adjustable light intensity
- Flexibility of light direction by fiber output
- RS232C remote control

Applications

- Photocatalyst
- Photochromism
- Artificial photosynthesis
- Chemical analysis
- etc.

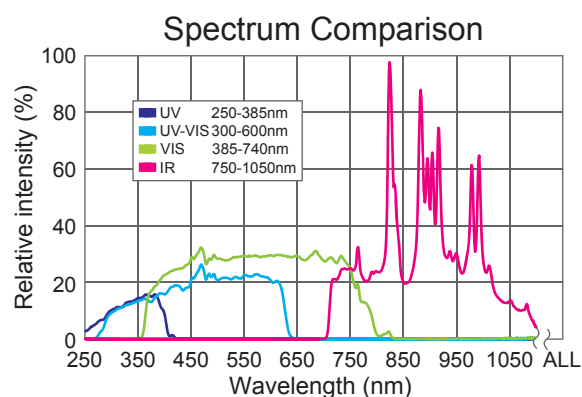

Extremely bright and heatless light source which can illuminate desired wavelength.

The MAX-303, 300W xenon light source, is the perfect illuminator with complete heat blocking design, using an originally designed mirror module. The MAX-303 has all useful functions such as mirror module, filter wheel, ND variable control, timed shutter and remote control.



Applications

Monochromatic Light with Optical Filters

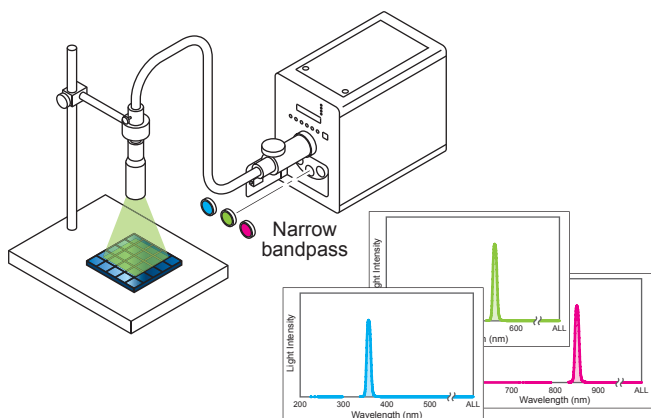

- Bright monochromatic light
- Instead of multiple wavelength laser
- Output beam is brighter than monochromator
- Selectable various wavelength by optical filters
- Unwanted IR heat and stray light are removed by mirror module

■ Narrow bandpass filter *Option

A wide variety of narrow bandpass filters from UV to IR wavelength range.

Lineup of 10nm interval from 260nm to 900nm

260nm, 270nm, 280nm, ..., 880nm, 890nm, 900nm



Photochemistry

Photochromic Materials Research

- Heatless monochromatic light source suitable for research of photochromic behavior
- Embedded filter wheel enables to select any desirable wavelength (UV - VIS)

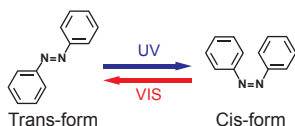
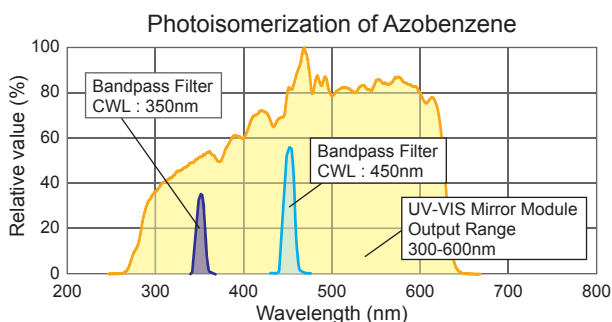

Photocatalytic Study

- Suitable for evaluation of wavelength response
- Embedded filter wheel enables to select any desirable wavelength (UV - VIS)

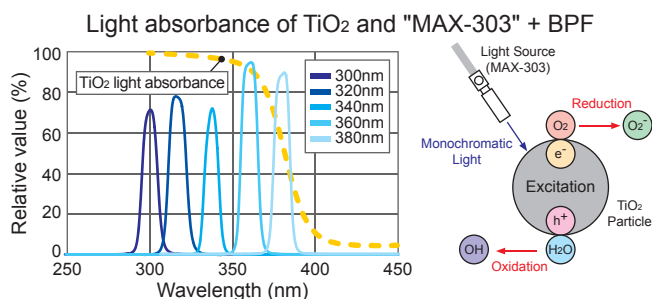

Applications

- Photocatalyst
- Chemical analysis
- Inspection lighting

- Photochromism
- Spectroscopy
- UV light disinfection

- Artificial photosynthesis
- Fluorescent observation
- Curing

...and for other Research & Development

Features

Optical System

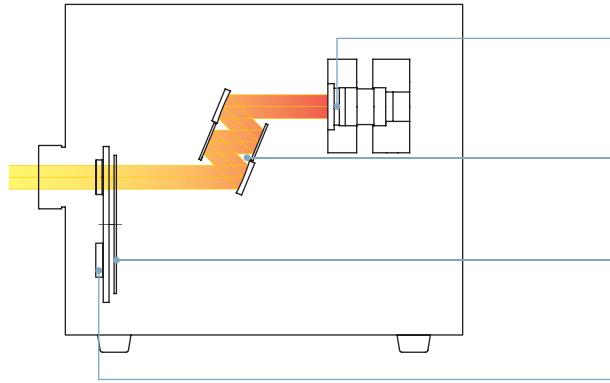

Xenon Lamp

Mirror Module

Light Intensity Control (ND Filter)

Filter Wheel

CERMAX Xenon Arc Lamp



300W Xenon arc lamp is built into the lamp unit. The lamp efficiency is enhanced by a parabolic reflector, and it achieves high intensity output with color temperature of 5600 Kelvin. The heat sink is also equipped on the unit.

Spectral Intensity of the Xenon Arc Lamp

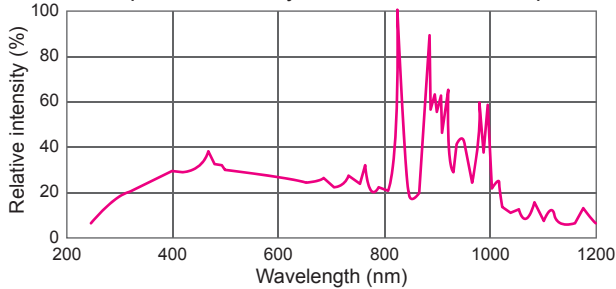

Mirror Module



This sophisticated optical unit consists of several cold mirrors to block unwanted energy from xenon lamp and only desired wavelength range is obtainable. The MAX-303 offers 4 types of mirror modules, UV, UV-VIS, VIS and IR types.

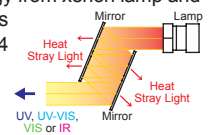

Mirror Module

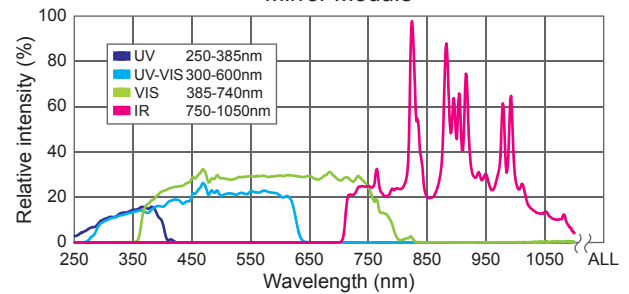

Light Intensity Control (ND Filter)



Built-in variable ND filter allows precise control of lamp intensity by 1 step within the range of 5 to 100 steps continuously as shown in the graph below.

Light Intensity Adjustment

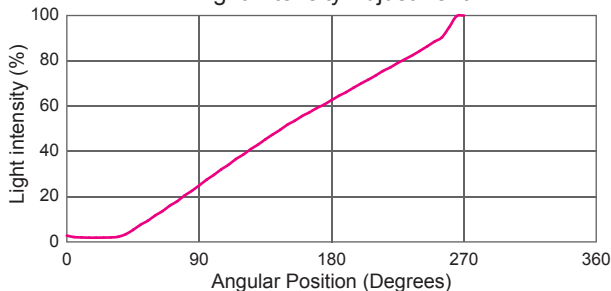

Filter Wheel



Max. 8 filters can be mounted on the filter wheel. To obtain desirable spectral output, wide varieties of shortpass, longpass and bandpass filters are available.

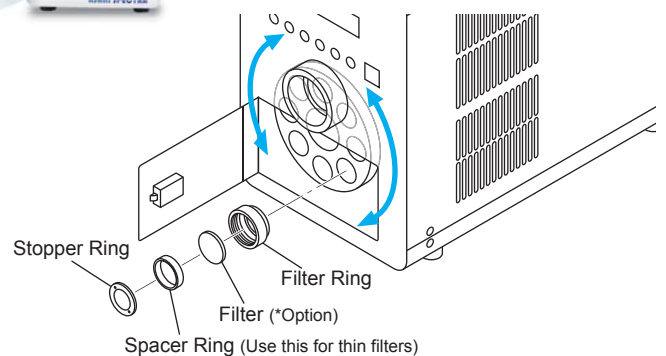

* Usable filter size: 25mm dia., thickness 1.0 - 6.0mm

Cartridge Type Lamp



The lamp is mounted into the cartridge. The lamp cartridge is easily replaced, optical axis adjustment is not required.



The lamp cartridge is not compatible with previous models: MAX-300, 301 or 302.

Panel Controls



User friendly menu and comprehensive display for easy operation.

1. Exposure time set 0.5-99999.9sec
2. Shutter activation Open/Close
3. Filter position control
4. Light intensity adjustment

Control by Computer



MAX-303 can be controlled remotely by using RS232C.

RS232C connector

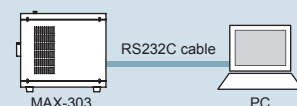

*All of those features can be controlled remotely via RS232C.

Options

Optical Filters



Asahi Spectra produces varieties of precise optical filters to help modification of spectral output from the MAX-303.

Our bandpass filter series allow users to obtain the desirable spectral throughput to suit wide variety of applications more precisely while eliminating unwanted energy.

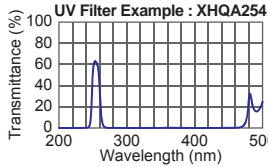

FWHM tolerance: 10±2nm
Min. transmission: 60%
Size: 25 mm dia.

Wavelength (nm)	Item #	Mirror Module
248	XHQA248	UV ¹
254 - 290	XHQA254 - XHQA290	UV ²
300 - 390	XHQA300 - XHQA390	
400 - 600	XHQA400 - XHQA450	UV-VIS ³
610 - 740	XBPA460 - XBPA600	
750 - 900	XBPA610 - XBPA740	IR
	XBPA750 - XBPA900	

*1 The OUV lamp is required.
*2 The mirror module transmittance is decreased when XHQA390 is used.
*3 The new version of XHQA300 - 390 are only available.
*Contact us for information about a filter which is not listed above.

Light Guide



The illuminating light from the MAX-303 is delivered to the point of use by the light guide efficiently. We carry single legged light guides as well as multi-legged types for your different needs.

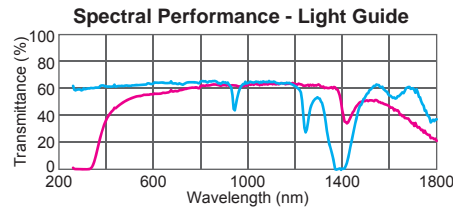

Quartz Light Guide
- Length(L): 1m, 2m
- Core dia: 200µm dia.
- Numerical aperture: 0.22
- Heatproof temp: <500 deg C (Incident end face)

Hybrid Light Guide
- Length(L): 1m, 2m
- Core dia: 50µm dia.
- Numerical aperture: 0.57
- Heatproof temp: <350 deg C (Incident end face)

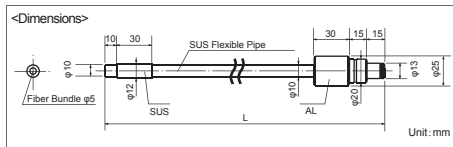

Collimator Lens



Collimator lens reduces the divergence of light from the light guide and provide uniform light output. It is suitable for directional backlighting which requires clear silhouette of an object.

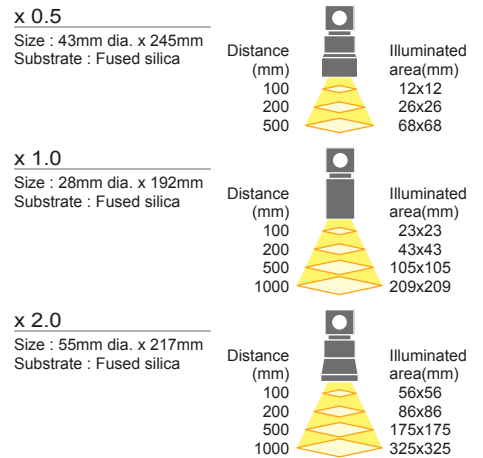

Scope of Delivery

- Lamp x 1 *Choose OUV, UV or VIS
- Mirror module x 1 *Choose UV, VIS, UV-VIS or IR
- Light guide adapter x 1 *Choose UV or VIS
- Filter ring x 8
- Filter fitting tool x 1
- AC cable x 1 (3-pin plug with ground 3-pin socket, 3m)
- RS232C cable (1.8m) x 1
- Instruction manual x 1



Caution OUV lamp generates a lot of ozone which is harmful to a human body. When you use it, you must prepare an exhaust system to evacuate ozone to outside.

Lamp and Mirror Module Combinations

*Design value **OUV lamp requires a duct unit.

Spectral Output	Lamp	Mirror Module	Light Guide Fitting Device
235* - 385nm	OUV**	UV	UV
300 - 600nm		UV-VIS	VIS
385 - 740nm		VIS	
750 - 1050nm		IR	
250 - 385nm	UV	UV	UV
300 - 600nm		UV-VIS	VIS
385 - 740nm		VIS	
750 - 1050nm	IR	IR	VIS
385 - 740nm	VIS	VIS	VIS
750 - 1050nm		IR	

General Specifications

Model: MAX-303
Output wavelength: 235* - 1050nm *Design value
(It depends on the lamp and the mirror module.)
Circuit method: Switching power supply
Input voltage: AC100 - 240V 50/60Hz
(Input range: AC100 - 240V)
Apparent power: Less than 530VA (AC100V/50Hz)
Less than 520VA (AC240V/50Hz)
Lamp type: Compact xenon lamp 300W
Lamp voltage, current: 14V, 21A (DC) *Representative value
Lamp life: 500h (Average)
*When the light intensity has decreased by 50% from the initial value.
Optical axis alignment: Cartridge type (Alignment-free)
Cooling method: Forced air cooling
Shutter: Pulsed motor drive
Exposure time set: 0.5 - 99999.9sec
Light intensity control: 100 - 5 (Steps) Continuously variable
Filter wheel: 8 channels *25mm dia/ t=6mm filter is usable
Mirror module: UV Type(250-385nm), UV-VIS Type(300-600nm),
VIS Type(385-740nm), IR Type(750-1050nm)
Controller: Built-in
Remote control: RS232C *The cable must be less than 3m.
Safety mechanism: Xenon lamp problem, Top door is open,
Lamp usage exceeds 500 hours, Cooling fan problem,
Temperature anomaly
Recommended environment: Temperature 10 - 35 deg C
Humidity 20 - 80% *Avoid condensation
Dimensions: 196(W) x 345(D) x 302(H)mm
Weight: 12.5kg (12.9kg with OUV lamp)

Dimensions

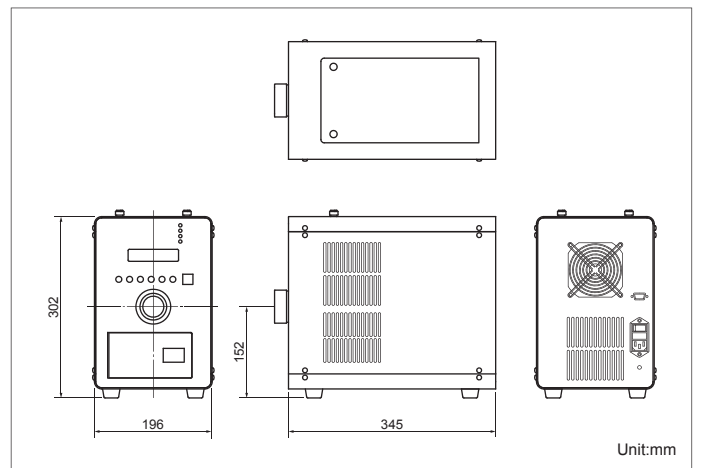

*Product specifications are subject to change without notice.



Gardenia Bldg. 4F, 2-13-1 Kamijujo, Kita-ku, Tokyo 114-0034 Japan
TEL : +81-3-3909-1151 / FAX : +81-3-3909-1152
Email : info@asahi-spectra.com

www.asahi-spectra.com